

CAMBRIDGE M-SERIES

DRAW THRU - DIRECT GAS-FIRED MAKE-UP AIR HEATERS

ENGINEERING SPECIFICATIONS MANUAL

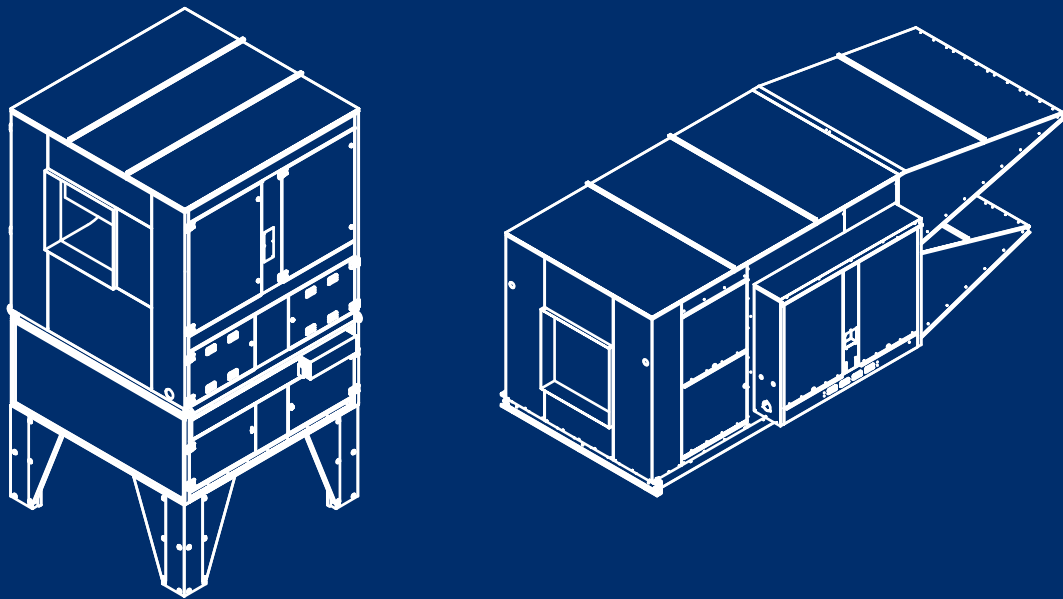

1,800 to 75,000 cfm
Complete Line of Accessories



760 Long Road Crossing Dr., Chesterfield MO 63005 • (636) 532-2233 • (800) 899-1989 • Fax (636) 530-6133 • www.cambridgeair.com



M-Series Make-Up Air Heaters

Unique Features & Benefits

Performance

- **Cambridge Burner** - Cambridge designs and manufactures its own proprietary, high efficiency stainless steel burners. Our design has the highest input rating per linear foot of burner (1000 MBH/ft). You can't get the high performance of a Cambridge burner unless you have a Cambridge heater.
- **Variable Air Volume System** is available with optional VFD (Variable Frequency Drive) Controls - The most effective and energy efficient way to compensate for varying amounts of exhausted air. Cambridge VFD designs provide competitive first cost while their greater efficiency provides lower operating costs.
- **ASHRAE 90.1 Compliant** - Cambridge M-Series Heaters can be labeled as complying with the latest requirements of ASHRAE Standard 90.1. This is a requirement for LEED Certified Green Buildings and a growing number of local, state, federal (DOE) building codes.

Reliability

- **Industry's Best Warranty Package** - Includes 2 years on the heater and 5 years on the stainless Cambridge burner.
- **Shielded & Ventilated Motor Assembly** - Motor is shielded from radiant heat of burner flame and is in the cool air stream - Lower maintenance and longer motor life.
- **Low Voltage Hot Surface Igniter** - The most dependable gas ignition system for gas fired products. Eliminates problems that conventional high voltage spark ignition systems have with moisture laden air.
- **Stainless Steel Burner & Flame Rod** - Reduces maintenance and increases service life.
- **Patented Low Fire Start Technology** - Increases reliability and saves energy by ensuring smooth and consistent main burner light-off without reliance on antiquated pilot ignition controls.
- **Watertight Housing** design with external drains (horizontal roof top configurations) - Stops ingested water from leaking into building by providing weep holes that drain outside the roof curb.
- **Closed Cell, Non-Water Absorbing Insulation** in the base of each horizontal unit - Eliminates condensation problems on underside of heater. Other conventional designs use less expensive, fiberglass insulation which absorbs moisture, effectively reducing its R-value.
- **Polyester Powder Coating** (optional) - Provides highest quality finish with longer service life.
- **Dual, Low Velocity Inlet Hoods** (optional) - Larger inlet surface reduces problems from rain and snow ingestion. Integral filter racks provide same surface area as V-Bank filter section (applicable to horizontal and vertical indoor configurations).

Safety

- **Cambridge Air Solutions was the first** manufacturer to have its Make-Up Air Heater tested and certified to the industry's harmonized joint US/Canadian standard for Non-Recirculating Direct Gas-Fired Industrial Air Heaters, ANSI Z83.4/CSA 3.7-M99.
- **Integral Non-Fused Disconnect Switch** - Increases safety for maintenance personnel and minimizes initial electrical field wiring expense.

Easy Installation and Serviceability

- **Mounting Flexibility** – Horizontal mounting includes: rooftop, thru-wall, under roof and pad mount options. Vertical mounting includes indoor and outdoor options.
- **External Profile Damper Adjustment** – Allows for simple, proper start-up. Eliminates the frustrating and time consuming heater start-up procedure associated with conventional designs that offer only internal profile adjustment.
- **Zero Clearance from Combustibles Rating** for heaters with the insulated housing option – Standard feature for all indoor units. Optional for outdoor units. Eliminates additional installation cost required for non-rated designs due to placement of non-combustible materials adjacent to the heater skin.
- **Factory Tested** as a fully-assembled heater – Minimizes initial start-up requirements.
- **Rigid Construction** – Supplied with structural perimeter base frame. Includes combination lifting eyes/hanging brackets for easy installation.
- **Integral Curb Counterflashing and Factory Assembled Inlet Accessories** – Reduces field labor cost and speeds up installation (horizontal configuration only).
- **Integral Pressure Gauge** for determining pressure drop across burner while adjusting profile dampers – Ensures accurate adjustment at start-up for most efficient operation.
- **Gas Valve Leak Test Switch** – Allows service technician to readily check the gas tightness of gas valve seats.
- **Service Switches** – Permits local control of blower and burner operation by service technicians.
- **Low Temperature Cutout** prevents building freeze-up. Shuts down blower when burner does not operate and outdoor air temperature is below setpoint. Field selectable setpoint (40°, 45°, 50°, 55°F).
- **Pre-Purge Timer** – Ventilates heater cabinet with minimum four air changes prior to ignition attempt. Selectable time periods up to 32 seconds. Accommodates any attached inlet ducting.
- **Class 2 Wiring for Remote Control Station** – Minimizes field wiring expense.
- **Entering Air Thermostat** – Economizer control to shut down burner operation during mild weather. Field selectable setpoint (45°, 50°, 55°, 57.5°, 60°, 62°, 64°, 66°, 68°, 70°F).

Variable Frequency Drive (VFD)

Cambridge M-Series Make-Up Air Heaters with optional VFD controls provide a solution for facilities that need to compensate for varying amounts of exhausted air. VFD is superior to other types of variable air volume systems because our technology varies the outside air supply without the need for continuous operation of the motor at full rated horsepower.

Benefits include:

- Ability of one system to efficiently handle changing exhausted air requirements
- Significantly lower electrical consumption and operating costs
- Better indoor air quality because Cambridge VFD systems use only fresh outside air and do not recirculate contaminated indoor air

Flexible VFD control options deliver precise performance to match the requirements of any facility. Contact your local Cambridge Representative for more information on VFD controls.

“The Performance Leader”

M-Series Make-Up Air Heater Specifications

General: The M-Series Direct Gas-Fired Make-Up Air Heater shall be factory assembled and tested to assure proper alignment of subassemblies and proper adjustment and performance of controls. Heaters must be CSA certified to the Standard for Non-Recirculating Direct Gas-Fired Industrial Air Heaters, ANSI Z83.4/CSA 3.7-M99. Heaters must be labeled as ASHRAE 90.1 compliant (*optional*). Horizontal Mount Heaters shall be manufactured for (*select one*): Rooftop Thru Wall Under Roof Pad Mount applications and configured with the discharge arrangement for (*select one*): Down Blast Horizontal Blast Up Blast. Vertical Mount Heaters shall be manufactured for (*select one*): Indoor Outdoor applications and configured for vertical mounting with the discharge arrangement for (*select one*): Horizontal Blast Up Blast.

Construction: The heater housing shall be constructed entirely of G90 galvanized steel and the finish shall be (*select one*): Unpainted (*standard*) Painted with a Gray Polyester Powder Coating (*optional*). Lifting eyes and hanging brackets shall originate from the base frame.

Base: The heater base shall have a full perimeter exterior frame constructed of 14 gauge steel (*for models M110, M112 & M115*) (*horizontal configuration only*) 12 gauge steel (*for models M118, M120 & M125*) 10 gauge steel (*for models M130, M136 & M140*), which forms the integral counterflashing for horizontal curb mount applications. The horizontal configuration heater base shall be manufactured with double wall floor panels constructed of 20 gauge steel (*for models M110, M112 & M115*) 18 gauge steel (*for models M118, M120, M125, M130, M136 & M140*) bottom pan and interior pan that encloses the 1/2" thick, non-water absorbing, closed cell, rubber insulation which is attached to the base panels with adhesive fully applied to bottom pan and rubber insulation. All floor panel joints shall be sealed to prevent any ingested moisture from leaking into the building. Weep holes, located outside the curb perimeter on horizontal heater configuration, shall be provided at the heater inlet to allow ingested moisture to drain from the heater base.

Housing: The heater cabinet is to be constructed of 20 gauge structurally reinforced housing panels (*for models M110, M112 & M115*) (*horizontal configuration only*) 16 gauge structurally reinforced housing panels (*for models M118, M120, M125, M130, M136 & M140* [*M140 Horizontal configuration only*]) The housing shall withstand a positive or negative pressure up to 2"WC without any adverse effects. An inlet bird screen is required.

The heater cabinet is to be (*select one*): Non-Insulated (*for models M118, M120, M125, M130, M136 & M140*) Fully, Internally Insulated with faced, 1" thick, 1 1/2 lb. density, NFPA 90A thermal and acoustical fiber glass insulation (mechanically fastened). The housing shall be of watertight construction with all joints caulked internally and externally. Unit access doors shall be Lift-off (*for horizontal configuration only*) Hinged (*for vertical configuration only*) with full perimeter gaskets and latches. Access doors shall be provided on both sides of the heater.

Blower: The blower shall be a Class I, double width, double inlet (DWDI), forward curved centrifugal fan with a galvanized steel wheel (*for models M110, M112, M115, M118, M120*), fully painted steel wheel (*for models M125, M130, M136 & M140*) and painted housing. The blower wheel shall be statically and dynamically balanced. The shaft shall be coated with a rust inhibitor. Shaft critical speeds shall be at least 1.25 times the maximum operating speed. The fan bearings shall be permanently lubricated self-aligning sealed ball bearings, resiliently mounted for sound and vibration attenuation (*for models M110, M112 & M115 [3HP]*) self-aligning, sealed ball or roller bearings with grease fittings (*for models M115 [5HP], M118, M120, M125, M130, M136 & M140*).

Motor/Drives: The motor shall be ___hp, ___volts, __phase, 60 hertz, ball bearing type, Open Drip Proof (*standard*)

Totally Enclosed Fan Cooled (*optional*) construction designed for continuous duty at 40°C with a 1.15 service factor rating.

The motor shall be shielded from radiant heat from the burner flame and mounted inside the heater housing in a cool air stream on an adjustable slide base. (Field wiring for the motor is required for model M140). The fan drive shall be a heavy duty V-belt drive designed for a minimum service factor of 1.50 based on motor horsepower. Motor sheaves shall be Fixed (*above 5HP*) Adjustable (*5HP and below*). Motors shall be permanently lubricated (10 hp and below) have grease fittings (above 10 HP).

Mounting Legs: For vertical mount only, the mounting legs shall be specified as 36" high 60" high

Burner: The direct gas-fired burner shall be manufactured by Cambridge Air Solutions and be suitable for: Natural Gas LP gas. The burner shall be capable of fully modulated operation over a temperature rise range of 5° through 110°F (for models M110, M112, M115, M118, M120, M125, M130 and M136) ____°F (for model M140, refer to table on page 19). The burner shall have stainless steel baffles and non-clogging orifices. The burner shall produce no more than 5 PPM (parts per million) carbon monoxide and 0.5 PPM nitrogen dioxide over its entire firing range. The burner shall be warranted by the burner manufacturer for a period of five years. The burner shall be furnished with a low voltage, hot surface ignition system; stainless steel flame rod; direct ignition of the main burner; automatic redundant safety shut-off gas valve(s); two lubricated manual shut-off valves; electric modulating gas valve with patented low fire start controls; gas pressure regulator; and temperature modulation controls to provide a complete assembled package.

Profile Plate: Burner profile plate adjustment shall be accomplished from a position that is outside of the heater, while the blower is operating. An integral pressure gauge to properly set the profile plate pressure drop shall be provided (*standard*).

Automatic profile damper motor system shall be supplied to automatically monitor and adjust the profile damper pressure drop (*optional*).

Gas Controls: The discharge temperature modulation control system shall be: Maxitrol Series 14 (*standard*) Maxitrol Series 44 with adjustable space temperature control and sensor (*optional*). A gas valve leak test switch shall be provided to readily permit field verification of the gas tightness of the valve seals (for units rated above 400 MBH). Gauge ports shall be provided to measure the gas supply pressure and the manifold gas pressure of the heater.

Electric Controls: The heater shall be furnished with factory mounted controls located in a weather resistant electrical control enclosure. Standard controls to include: selectable low temperature cutout control to shut down the heater if the burner fails to operate on a call for heat within four minutes or when the heater is operating in the ventilation mode and the outdoor temperature drops below the temperature setpoint; selectable entering air thermostat to turn off burner in milder weather; patented low fire start control system to permit direct ignition of the main burner at a reduced firing rate; IEC rated magnetic motor contactor; IEC rated overload with single phase protection; control voltage transformer; control circuit fusing; Class 2 transformer for remote control wiring; and a non-fused NEMA 4 disconnect switch fuse block for branch circuit protection (*optional*). The terminal strip shall be pre-labeled for field wiring connections.

Safety Controls: The standard safety controls on the heater shall include: solid state flame safeguard relay; flame sensing element (stainless steel flame rod); manual reset high temperature limit; integrated, selectable pre-purge timer; motor starter auxiliary contact interlocked with gas valve circuit; redundant gas valves; high and low airflow switches high gas pressure switch (*if gas supply pressure exceeds 14"WC*).

For selection and definition of additional options and controls, including VFD (Variable Frequency Drive), see pages 14-18

M-Series Selection Procedure

1. Select desired airflow _____ cfm NOTE: "Net Room Air" = _____ cfm

(see formula on page 19)

2. Determine temperature criteria:

Indoor design temperature _____ °F
 Plus 10-20°F + _____ °F
 Discharge air temperature = _____ °F
 Less outdoor design temp. - _____ °F
 Temperature rise (ΔT) = _____ °F

(Refer to table on page 19 for maximum temperature rise).

3. Job location _____

Elevation _____ feet above sea level (from chart at right)

4. Select desired heater: M- _____ (from table below)

- Horizontal mount Horizontal blast Up blast Down blast
 Vertical mount Horizontal blast Up blast

City	Elev.	Barom. Press. "Hg
Atlanta	1010	28.84
Baltimore	148	29.76
Boston	15	29.90
Buffalo	705	29.17
Calgary	3428	26.39
Charlotte NC	736	29.13
Chicago	607	29.97
Cincinnati	758	29.11
Cleveland	777	29.09
Columbus OH	812	29.05
Dallas	481	29.40
Denver	5283	24.63
Detroit	619	29.26
Indianapolis	792	29.07
Kansas City	791	29.07
Louisville	489	29.39
Memphis	258	29.64
Milwaukee	672	29.20
Minneapolis	834	29.03
Nashville	590	29.29
NYC/Newark	10	29.91
Omaha	977	28.88
Philadelphia	5	29.91
Pittsburgh	1137	28.71
Reno	4404	25.45
Richmond VA	164	29.74
St Louis	535	29.35
Salt Lake City	4220	25.63
Seattle	449	29.44
Toronto	568	29.38
Wichita	1321	28.52

Model (cfm)								
M110*	M112*	M115*	M118	M120	M125	M130	M136	M140*
1,800	2,500	4,000	6,000	10,000	15,000	20,000	28,000	40,000
to	to	to	to	to	to	to	to	to
3,250	4,000	7,500	10,000	17,000	26,000	36,000	50,000	75,000

*Horizontal Mount Only

5. Calculate accessory static pressure losses: (page 7)

Rain hood + _____ "WC
 Inlet or discharge damper + _____ "WC
 Filters + _____ "WC
 Discharge plenum/Ductless discharge + _____ "WC
 Additional ductwork & accessories + _____ "WC
 LP gas (add 0.22") + _____ "WC
Total External Static Pressure (TESP) = _____ "WC

6. Select motor horsepower: _____ (page 8)

7. Calculate burner input (MBH) @ sea level and 70°F discharge temperature:

Blower cfm x 1.08 x ΔT ÷ 0.92 ÷ 1000 = Burner input_{sea level} (MBH)
 _____ cfm x 1.08 x _____ °F ÷ 0.92 ÷ 1000 = _____ (MBH)

8. Select burner length based on burner input_{sea level} (MBH): _____ " (page 9)

9. Calculate rated heater input for specific application @ job location:

Burner input (per step 7b) _____ x correction factor to sea level (table below) _____ = _____ MBH Rated heater input

Burner Correction Factor to Sea Level									
Discharge Temperature		50°F	60°F	70°F	80°F	90°F	100°F	110°F	120°F
0 Feet (29.92 "Hg) SL		1.039	1.019	1.000	0.981	0.964	0.946	0.930	0.914
500 Feet (29.38 "Hg)		1.020	1.001	0.982	0.964	0.946	0.929	0.913	0.897
1,000 Feet (28.85 "Hg)		1.002	0.983	0.964	0.946	0.929	0.913	0.897	0.881
5,000 Feet (24.89 "Hg)		0.865	0.848	0.832	0.816	0.802	0.787	0.774	0.760

10. Specify gas supply: _____ psi _____ "WC _____ oz natural gas LP gas

Specify electric supply: _____ volt _____ Ph _____ Hz

11. Select gas, electric and VFD controls (pages 16-19)

12. Weight and dimension information on page 10 or 12.

Static pressure losses from accessories should be added to other system airflow resistances, such as ductwork, grills and diffusers in order to determine the Total External Static Pressure (TESP) of the heater.

Inlet Options

Model (cfm)								Accessory Static Pressure ("WC)					
M110/ 112	M115	M118	M120	M125	M130	M136	M140	Single Rain Hood ¹	Dual Rain Hoods ²	Inlet Damper	Inlet screen	Filters ³	
												Throw Away	Perm- anent
1,800								0.04	0.02	0.03	0.04	0.07	0.02
2,200	4,000	6,000			20,000			0.06	0.03	0.04	0.06	0.10	0.04
2,600	4,700	7,000	11,000	17,000	23,000	31,000	46,000	0.08	0.04	0.06	0.09	0.14	0.05
3,000	5,400	8,000	13,000	19,000	27,000	36,000	54,000	0.11	0.06	0.08	0.11	0.19	0.07
3,400	6,100	9,000	15,000	22,000	31,000	40,000	60,000	0.14	0.07	0.10	0.15	0.24	0.09
3,800	6,800	10,000	16,000	24,000	34,000	45,000	67,000	0.17	0.09	0.12	0.18	0.30	0.11
	7,500					50,000	75,000	0.21	0.11	0.15	0.23	0.37	0.13

Discharge Options

Model (cfm)									Accessory Static Pressure ("WC)				
M110	M112	M115	M118	M120	M125	M130	M136	M140	Discharge Damper	Discharge Plenum	Discharge Diffuser	Discharge Elbow	Ductless Discharge ⁴
1,800		4,000	6,000			20,000			0.12	0.06	0.08	0.14	0.29
2,100	2,600	4,700	7,000	11,000	17,000	23,000	31,000	46,000	0.17	0.08	0.11	0.20	0.41
2,400	3,000	5,400	8,000	13,000	19,000	27,000	36,000	54,000	0.23	0.11	0.15	0.26	0.55
2,700	3,400	6,100	9,000	15,000	22,000	31,000	40,000	60,000	0.28	0.13	0.18	0.33	0.68
3,000	3,800	6,800	10,000	16,000	24,000	34,000	45,000	67,000	0.36	0.17	0.23	0.41	0.87
							50,000	75,000	0.44	0.21	0.28	0.51	1.07

¹Not available on model M140.

²Not available on models M110, M112 and M115.

³Assumes air filters are in clean condition.

⁴Ductless Discharge applies when there is no connecting ductwork at the outlet of the heater. It represents the static pressure loss incurred from a centrifugal fan discharging directly into an open space or plenum (bulkhead effect). To eliminate this loss, the equivalent straight ductwork length of 2.5 times the blower wheel diameter should be connected to the discharge of the heater.

Heater & Motor Horsepower Selection

Airflow (cfm)	Total External Static Pressure (TESP)													
	0.25"WC		0.50"WC		0.75"WC		1.00"WC		1.25"WC		1.50"WC		1.75"WC	
	M110		M110		M110		M110		M110		M110		M110	
1,800	1		1		1		1		1		2		2	
2,000	1		1		1		2		2		2		2	
2,250	1	M112	1	M112	2	M112	2		2		2		2	
2,500	2	1	2	1	2	2	2	M112	2		2		2	
2,750	2	1	2	2	2	2	2	2	2	M112	2	M112		
3,000	2	2	2	2	2	2	2	2	2	2	2	2		M112
3,250	2	2	2	2		2	2	2	2	3	3	3		3
3,500		2	2	2		2	2	3	3	3	3	3		3
3,750	M115	2	M115	2		3	3	3	3	3	3	3		3
4,000	2	3	2	3	M115	3	M115	3	M115	3	M115	3	M115	
4,500	2		2		3		3		3		3		5	
5,000	2		3		3		3		5		5		5	
5,500	3	M118	3	M118	3	M118	5	M118	5	M118	5	M118	5	
6,000	3	3	5	3	5	3	5	5	5	5	5	5	M118	5
6,500	5	3	5	3	5	5	5	5	5	5	5	5		M118
7,000	5	3	5	5	5	5	5	5	5	5	5	5		7½
7,500	5	5	5	5	5	5	5	5	7½	7½	7½	7½		7½
8,000		5	5	5		5	7½	7½	7½	7½	7½	7½		7½
8,500		5	5	5		7½	7½	7½	7½	7½	7½	7½		7½
9,000		7½	7½	7½		7½	7½	7½	7½	7½	7½	7½		
9,500	M120	7½	M120	7½	M120	7½	M120	7½	M120		M120			
10,000	5	7½	5	7½	7½	7½	7½		7½		7½		M120	
11,000	7½		7½		7½		7½		7½		10		10	
12,000	7½		7½		7½		10		10		10		15	
13,000	10		10		10		10		15		15		15	
14,000	10	M125	10	M125	15	M125	15		15		15		15	
15,000	15	7½	15	7½	15	7½	15	M125	15		15		15	
16,000	15	7½	15	7½	15	10	15	10		M125				
17,000	15	7½		10		10		10		15		M125		
18,000		10		10		10		15		15		15		M125
19,000	M130	10	M130	10	M130	15	M130	15		15		15		15
20,000	7½	10	7½	15	10	15	10	15	M130	15	M130	15		20
22,000	10	15	10	15	10	15	15	20	15	20	15	20	M130	20
24,000	10	15	15	20	15	20	15	20	15	20	20		20	
26,000	15	20	15	20	15		15		20		20		20	
28,000	15	M136	15	M136	20	M136	20	M136	20	M136	20	M136	25	M136
30,000	15	15	20	15	20	15	20	20	25	20	25	20	25	25
32,000	20	15	20	15	25	20	25	20	25	20	25	25	30	25
34,000	25	15	25	20	25	20	25	20	30	25	30	25	30	25
36,000	25	20	25	20	30	20	30	25	30	25		25		30
38,000		20		25	30	25		25		30		30		30
40,000	M140	25	M140	25	M140	25	M140	30	M140	30	M140	40	M140	40
42,000	20	25	20	30	25	30	25	30	25	40	30	40	30	40
44,000	20	30	20	30	25	40	25	40	30	40	30	40	40	40
46,000	20	40	25	40	25	40	30	40	30	40	40		40	
48,000	25	40	25	40	30	40	30	40	40		40		40	
50,000	25	40	30	40	30		40		40		40		40	
54,000	30		30		40		40		40		40		50	
58,000	40		40		40		40		50		50		50	
62,000	40		40		50		50		50		60		60	
66,000	50		50		50		60		60		60		60	
70,000	50		60		60		60		75		75		75	
75,000	60		75		75		75		75					

Over 1.75" WC TESP consult factory.

Burner Data			Standard Pressure ²				Low Pressure ³			
Burner Length	Max Burner Input ⁴ (MBH)	Max Gas Supply Pressure ⁵	Minimum Gas Supply Pressure based on Gas Train Pipe Size ("WC)				Max Burner Input ⁴ (MBH)	Minimum Gas Supply Pressure based on Gas Train Pipe Size ("WC)		
			¾"					¾"		
6"	454	14"WC	7.5				375	6.0		
8"	612	14"WC	9.8	1"			500	6.0	1"	
12"	928	1 psi		9.7	1¼"L		750		6.0	1¼"L
16"	1240	1 psi	1¼"H		8.5		1000	1¼" H		6.0
20"	1565	5 psi	9.7				1250	6.0	1½"	
24"	1906	5 psi	10.2				1500		6.0	2"
28"	2244	5 psi	11.7	1½"			1750			6.0
32"	2588	5 psi	13.7	12.1			2000			6.0
36"	2952	5 psi	16.4	14.0	2"		2250	2½"		6.0
40"	3110	5 psi	17.2	14.4	9.7		2500	6.0		
44"	3675	5 psi	24.0	19.0	11.3		2750	6.0		
48"	4056	5 psi	29.9	22.6	12.2		3000	6.0	3"	
54"	4630	5 psi	42.2	29.9	13.6	2½"	3375		6.0	
60"	5225	5 psi	3"	40.6	15.4	13.5	3750		6.0	
66"	5830	5 psi	15.6		17.5	16.5	4125		6.0	
72"	6456	5 psi	16.3		20.0		4500		6.0	

¹Consult factory for LP gas pressure requirements.

²STANDARD PRESSURE is considered to be between the Minimum and Maximum Gas Supply Pressure listed for the heater.

³LOW PRESSURE is considered to be between 6"WC and the Minimum Standard Pressure.

⁴Maximum Burner Input is based on a 70°F discharge temperature at sea level.

⁵A high pressure gas regulator is required if the Standard Gas Supply Pressure exceeds the maximum value shown.

Burner Length	M110	M112	M115	M118	M120	M125	M130	M136	M140
Minimum	6"	6"	6"	12"	12"	16"	20"	28"	28"
Maximum	8"	8"	16"	32"	36"	48"	72"	72"	72"

Electrical Requirements

Total Heater Amperage⁶

Motor Horsepower	Input Power						
	120V/1Ph	208V/1Ph	230V/1Ph	208V/3Ph	230V/3Ph	460V/3Ph	575V/3Ph
1	18.6	9.8	9.3	6.0	5.5	2.8	2.2
2	26.6	14.6	13.3	8.9	8.1	4.1	3.2
3	36.6	20.1	18.3	12.0	10.9	5.5	4.4
5	58.6	32.2	29.3	18.1	16.5	8.3	6.6
7½	82.6	45.4	41.3	25.6	23.3	11.7	9.5
10	102.6	56.4	51.3	32.2	29.3	14.7	11.5
15				47.6	43.3	21.7	17.5
20				60.8	55.3	27.7	22.5
25				76.2	69.3	34.7	27.5
30				89.4	81.3	40.7	32.5
40				115.4	105.3	52.7	41.5
50				144.4	131.3	65.7	52.5
60				170.4	155.3	77.7	62.5
75				212.4	193.3	96.7	77.5

⁶Includes control amps based on 300VA control circuitry load.

Horizontal Mount - Dimensions and Weights

Dimensions

Reference	M110	M112	M115	M118	M120	M125	M130	M136	M140
A	76.61"	76.61"	76.61"	94.81"	94.81"	112.31"	112.31"	116.5"	148.36" ²
B	30"	30"	44"	48.6"	54.6"	66.6"	88.3"	88.3"	117.57"
C	33.06"	33.06"	33.06"	52.81"	52.81"	69.56"	69.56"	94.56"	98.94"
D ¹	5.98"	5.98"	5.98"	17.62"	11.06"	17.94"	9.28"	30.33"	13.86"
E	13.44"	15.88"	15.88"	18.57"	24.69"	31.27"	36.58"	43.08"	50.02"
F	12.35"	12.98"	18.66"	22.00"	24.81"	31.43"	36.82"	42.90"	49.90"
G (L/R for M112)	8.81"	6.5"/10.5"	12.67"	13.38"	15.06"	17.81"	25.95"	22.89"	35.32"
H	12.49"	10.34"	10.34"	13.12"	13.12"	18.69"	18.69"	16.84"	6.69"
J	N/A	N/A	N/A	12.11"	12.11"	12.11"	12.11"	12.11"	18.66"
K	30"	30"	30"	30"	30"	30"	36"	36"	(A)
L1	N/A	N/A	N/A	33.84"	43.42"	52.47"	61.91"	81.76"	82.49"
L2	N/A	N/A	N/A	43.36"	64.17"	77.59"	82.77"	96.62"	99.19"
L3	49.61"	49.61"	53.39"	47.82"	66.51"	76.51"	83.04"	83.04"	N/A
M (width)	17.59"	17.59"	32.66"	45.65"	51.65"	62.65"	84.24"	84.24"	118.45"
N (height)	28.79"	28.79"	28.79"	47.09"	47.09"	63.38"	63.38"	88.38"	89.84"
Inlet opening	3.52 ft ²	3.52 ft ²	6.53 ft ²	14.93 ft ²	16.89 ft ²	27.57 ft ²	37.08 ft ²	51.70 ft ²	70.79 ft ²

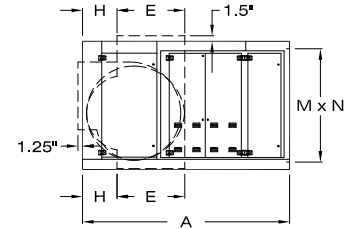
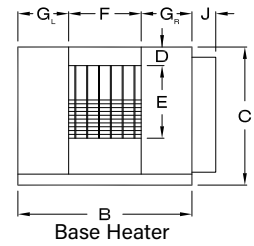

¹For units with internal vibration isolators this dimension is reduced by .63" for M110 thru M115 or 1.25" for M118 thru M136

²Total of blower module (97.28") and burner module (51.08").

A = Consult Factory

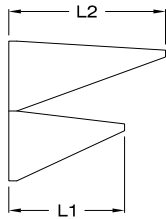

Dual Rain Hoods

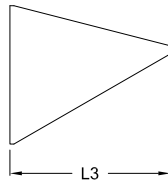

Single Rain Hood



Filter Section

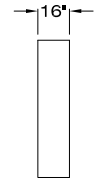

Inlet Collar

Weights (lbs.)

Accessory	M110	M112	M115	M118	M120	M125	M130	M136	M140
Base Heater	425	440	550	1125	1395	2045	2475	2845	5345 ³
Rain Hood - Single	45	45	70	135	175	275	325	375	N/A
Rain Hood - Dual, upper	N/A	N/A	N/A	95	145	240	270	325	480
Rain Hood - Dual, lower	N/A	N/A	N/A	75	105	170	205	280	410
Filters for Rain Hood	10	10	15	20	30	45	60	80	90
Inlet Screen	5	5	10	10	15	25	35	40	45
Inlet Collar	40	40	50	85	110	170	200	230	335
Inlet Damper	25	25	35	55	65	125	155	210	290
V-Bank Filter Section	70	70	100	215	235	285	400	500	(A)
Discharge Duct - 50"	60	70	80	90	120	140	160	180	200
Discharge Duct - 72"	70	85	95	125	150	180	220	250	280
Discharge Damper	N/A	N/A	N/A	30	30	35	45	55	75
Discharge Plenum 4-Way	100	150	200	250	300	400	470	930	1480
Discharge Plenum 3-Way	80	130	175	220	260	360	430	500	795
Discharge Splash Pan	40	40	40	60	60	60	80	80	80
Curb - 14"	60	70	80	100	120	180	210	230	270
Curb - 24"	100	120	140	170	200	270	310	340	445

³Total of blower module (3625 lbs.) and burner module (1720 lbs.)

A = Consult Factory

Horizontal Mount - Typical Configurations

Outdoor Rooftop

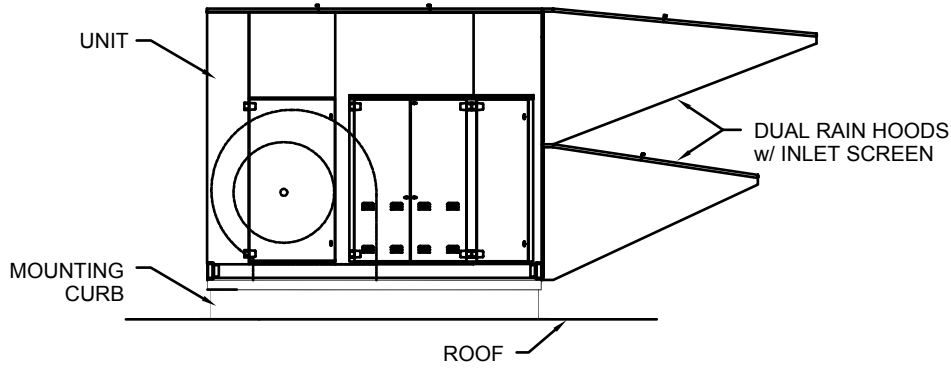

Indoor Thru Wall

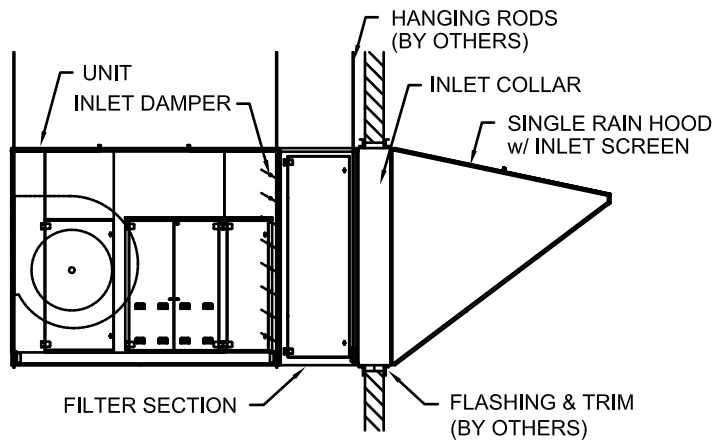

Outdoor Pad Mount

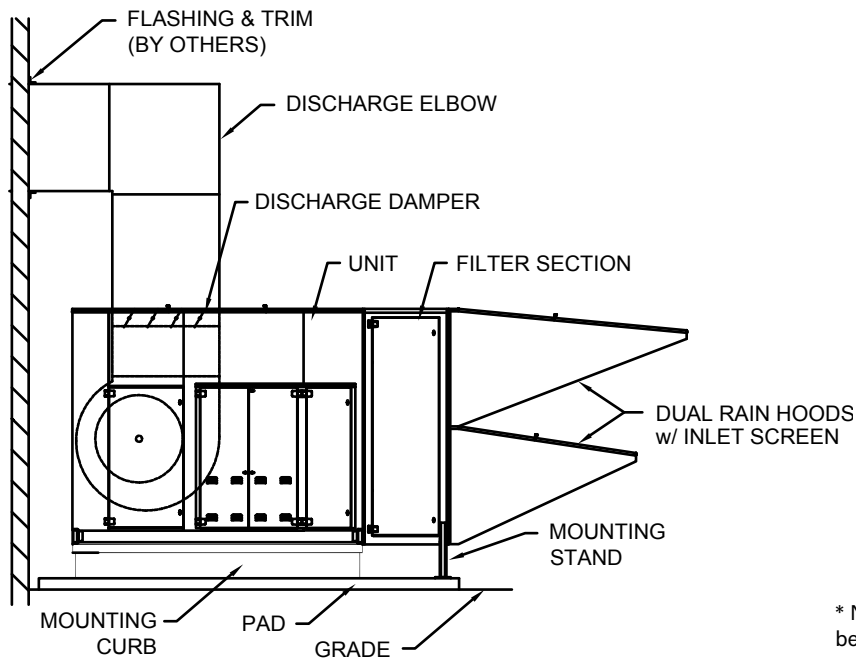

* NOTE: Structural support platform should be supplied by others if mounting height is greater than 24".

Vertical Mount - Dimensions and Weight

Dimensions

Reference	M118	M120	M125	M130	M136
A	68"	73"	79"	84"	89.63"
B	67"	73"	79"	99.5"	105"
C	67.50"	74.5"	82"	91.5"	94.5"
D	13.11"	14.23"	15.21"	18.39"	15.61"
E	18.82"	24.69"	31.19"	36.69"	43.00"
F	21.82"	25.00"	31.50"	36.93"	42.88"
G	15.48"	17.04"	16.79"	24.29"	24.04"
H	7.16"	5.28"	15.48"	18.28"	19.47"
J1	20"	29"	30"	36"	36"
J2	24"	33"	34"	40"	40"
J3	11"	11"	11"	11"	11"
J4	60"	60"	84"	84"	100"
J5	52.81"	52.81"	69.56"	69.56"	94.56"
J6	48"	54"	66"	87.69"	87.69"
K1	42.33"	61.17"	73.79"	77.95"	95.62"
K2	32.67"	39.93"	49.05"	57.59"	75.21"
K3	45.43"	63.92"	76.51"	80.58"	84.75"
L1	62.89"	67.89"	73.89"	78.89"	84.52"
L2	62.24"	67.24"	73.24"	78.24"	83.87"
L3	44.25"	44.25"	61"	61"	86"
M1	48.45"	54.45"	60.45"	80.95"	86.45"
M2	61.24"	63.9"	73.24"	93.74"	99.24"
M3	44"	50"	57.44"	77.94"	83.44"
Inlet opening L1xM1	21.16 ft ²	25.67 ft ²	31.02 ft ²	44.35 ft ²	50.74 ft ²

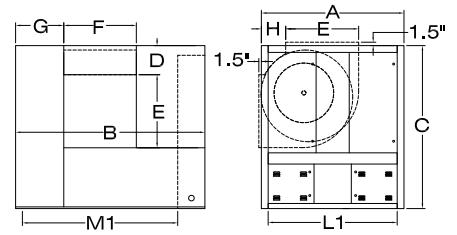

Base Heater

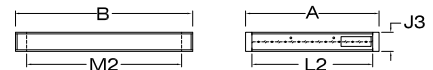

Inlet Damper

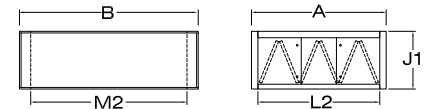

V-Bank Filter Section

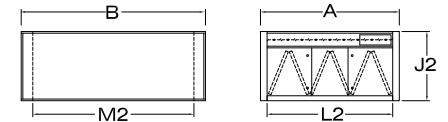

V-Bank Filter Section
w/Inlet Damper

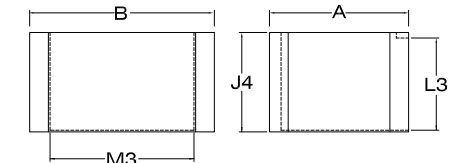

Inlet Elbow

Weights (lbs.)

Accessory	M118	M120	M125	M130	M136
Base Heater	1800	2300	2900	3200	3600
Rain Hood - Single	105	165	285	395	485
Rain Hood - Dual, Upper	80	120	210	290	345
Rain Hood - Dual, Lower	55	90	150	210	275
Filters for Rain Hood	20	30	45	60	80
Inlet Collar	100	110	170	200	230
Inlet Elbow	450	500	780	1040	1325
Inlet Damper	305	345	400	475	490
V-Bank Filter Section	280	380	420	553	715
Filter Section/Inlet Damper Combo	470	600	670	860	920
Discharge Duct - 50"	90	120	140	160	180
Discharge Duct - 72"	125	150	180	220	250
Discharge Damper	35	35	40	58	75
Discharge Elbow95	120	170	230	340	
Mounting Legs 3' (set of 4)	253	253	253	253	253
Mounting Legs 5' (set of 4)	404	404	404	404	404

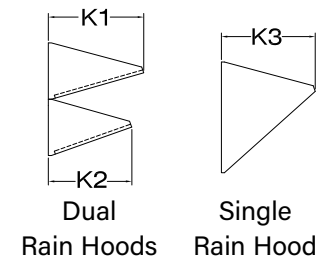

Dual Rain Hoods Single Rain Hood

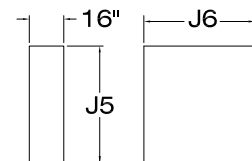

Inlet Collar

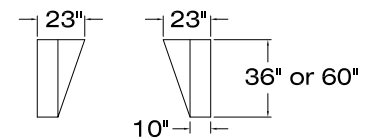

Mounting Legs

Vertical Mount - Typical Configurations

Indoor

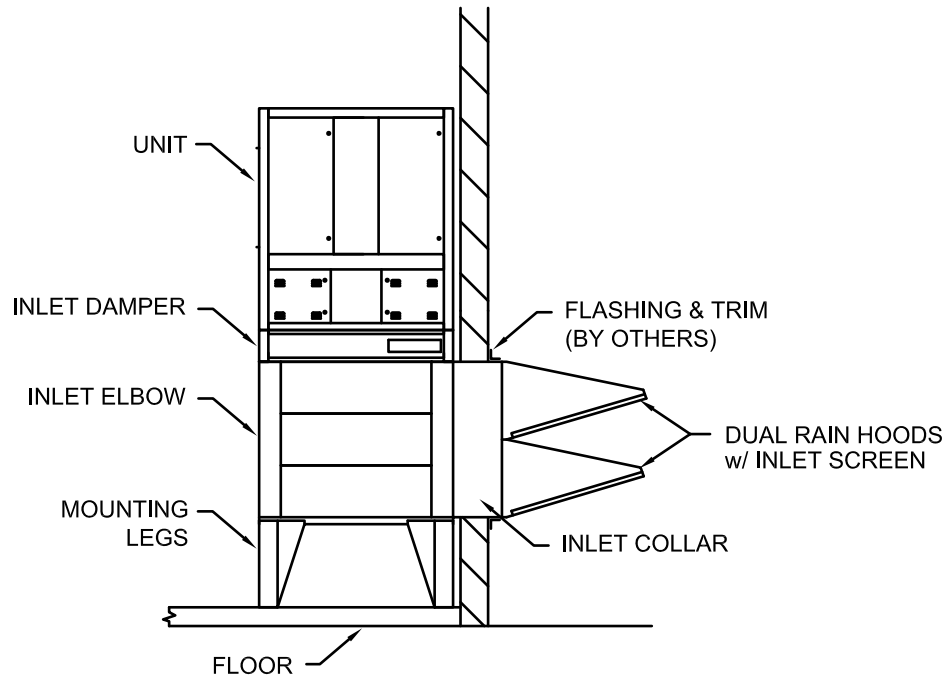

Outdoor

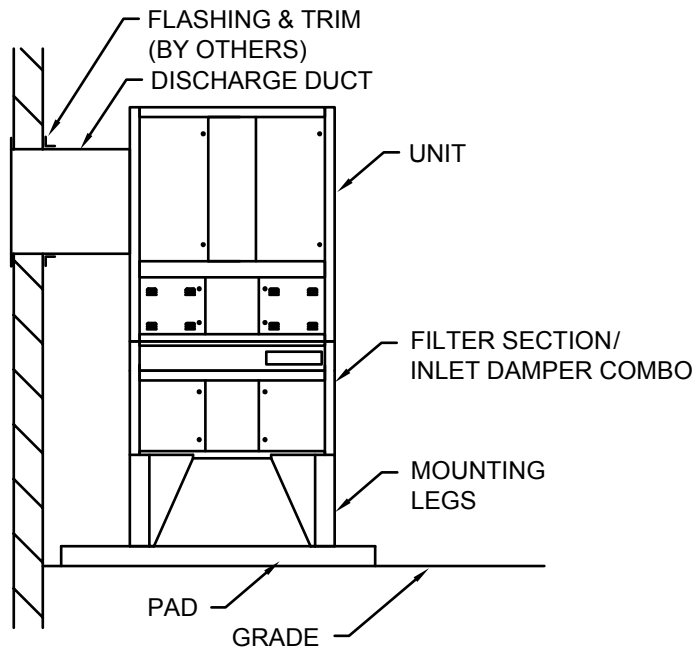

Inlet Options

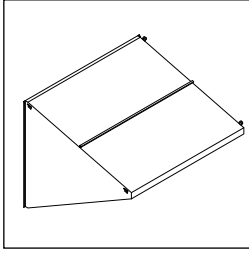

Single Rain Hood Single rain hood with integral bird screens. Equipped with integral filter rack for M110, M112 and M115 units. (Integral filter rack is not available for models M118, M120, M125, M130 or M136.) (Not available for M140)

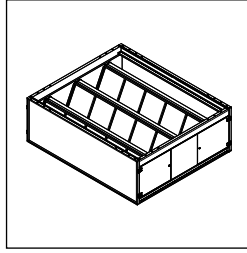

V-Bank Filter Section Attaches to heater inlet and is supplied with filter access doors. Filters may be: [2" Permanent Metal Mesh] [2" Moisture Resistant Throw-Away Panel] or [2" Pleated 30/30].

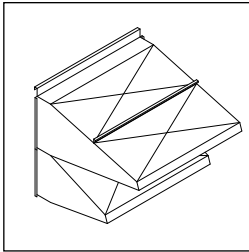

Dual Rain Hoods Dual rain hoods with integral bird screens designed with lower inlet velocity (below 550 ft/min) than the single rain hood. Equipped with racks for mounting filters which are either [2" Permanent] or [2" Moisture Resistant Throw-Away Panel]. (Not available for models M110, M112 or M115.)

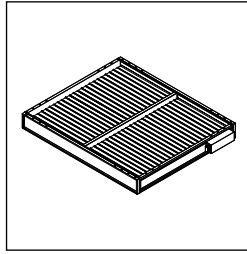

Inlet Damper Section Utilizes a heavy-duty, two-position damper motor with an integral end switch that signals the motor when the damper is open. Field wiring required on vertical mount configurations. (Integral on horizontal mount configuration.)

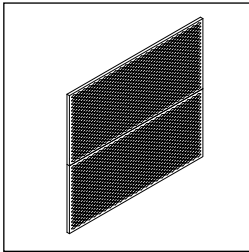

Inlet Screen Required when the heater is supplied without the rain hood.

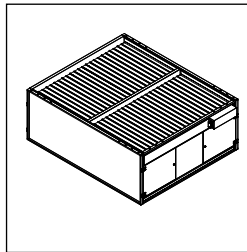

Inlet Damper/Filter Section Combo Inlet damper and filter section combined in a single housing, field wiring required. (For vertical mount configuration only.)

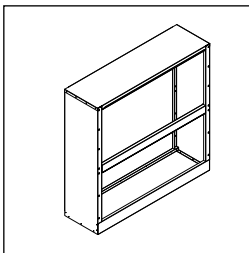

Inlet Collar 16" deep, insulated wall sleeve designed to support rain hoods for horizontal indoor thru wall and vertical indoor applications.

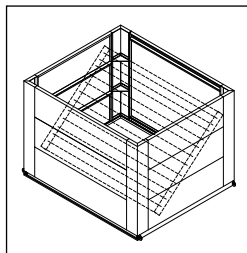

Inlet Elbow Fully insulated structural housing. Includes turning vanes. (For vertical mount configuration only.)

Other Inlet Options

Cooling

- DX Cooling Coils
- Chilled Fluid Cooling Coils
- Evaporative Cooling

Consult factory for selection and sizing

Special Filters

Single and multistage high efficiency filters and housings

Heating/Preheating

Steam or fluid coils for heat recovery from exhaust air or process heat

Discharge Damper Utilizes a heavy-duty, two-position damper motor with an integral end switch that signals the motor when the damper is open. The damper is factory mounted in the fan discharge and is integral with the heater housing. (Not available for models M110, M112 or M115.)

Discharge Duct 20", 50" or 72" long, insulated duct.

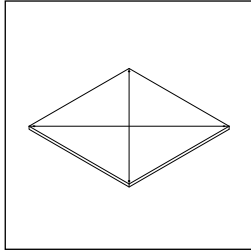

Splash Pan Designed for downblast configurations. It is suspended below the discharge duct and disperses the air randomly. Requires additional support rods (provided by others). Provides lower discharge velocities. The Splash Pan is the most economical discharge accessory.

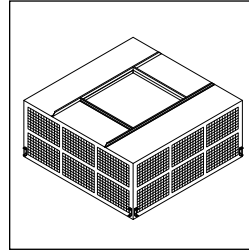

4-Way Discharge Plenum Designed for downblast configurations. It is attached to the end of the discharge duct and disperses air horizontally in all directions through permanently attached grilles. Requires additional support rods (provided by others). Provides lower discharge velocities. Removable grille option is also available.

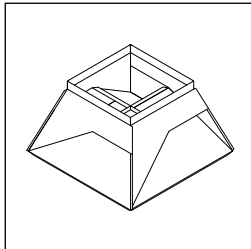

4-Way Downblast Discharge Diffuser Designed for downblast configurations. It is attached to the end of the discharge duct and disperses the air downward at approximately a 45° angle in all directions. Provides higher discharge velocities.

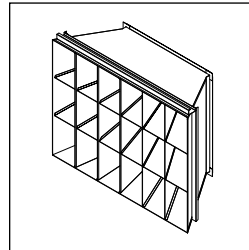

3-Way Horizontal Blast Discharge Diffuser Designed for horizontal blast configurations. It is attached to the end of the discharge duct and disperses the air downward at approximately a 45° angle. Requires additional support rods (provided by others). Provides higher discharge velocities.

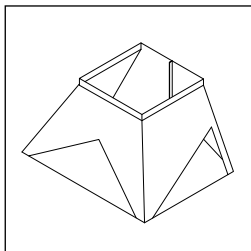

3-Way Downblast Discharge Diffuser Designed for downblast configurations. It is attached to the end of the discharge duct and disperses the air downward at approximately a 45° angle in 3 directions, typically used where a heater is discharging close to a wall or other obstruction. Provides higher discharge velocities.

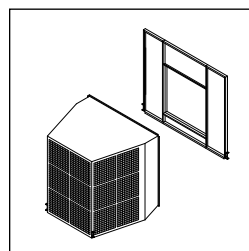

3-Way Discharge Plenum (with Enclosure) Designed for horizontal blast configurations. It is either attached to the end of the discharge duct (Enclosure required) or the end of the heater. Disperses the air horizontally in 3 directions through permanently attached grilles. Requires additional support rods (provided by others). Provides lower discharge velocities. Removable grille option is also available.

Mounting and Service Options

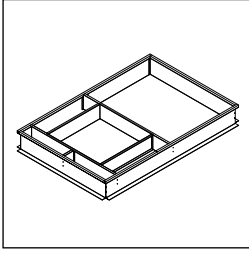

Mounting Curb Used on horizontal rooftop or pad mount applications and shipped disassembled. Includes an integral wood nailer. Duct supports provided for downblast configuration. Specify 14" or 24" height. Contact factory if sloped curbs are required.

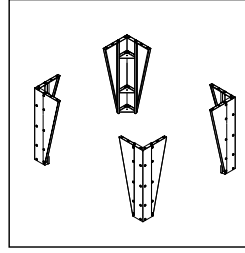

Mounting Legs Structurally reinforced leg assembly for vertical mount configuration. Specify 3' or 5' height.

Vibration Isolators For both internal and external horizontal mount applications. For internal isolation, blower and motor assembly are mounted on isolated platform. (*Internal Vibration Isolators not available for models M110, M112 or M115*). External isolation either base mount or suspended. (*Base mount is not compatible with standard roof curb*).

Gas Control Options

Maxitrol Series 14 Modulating Controls (Standard) Electronic discharge temperature control system maintains a constant discharge temperature. Control permits manual adjustment of discharge temperature (55° to 90°F) from inside the heater control enclosure. (*Standard*) A Remote Heat Adjust control with override capability to 130°F can be provided to allow manual adjustment of discharge temperature (55° to 130°F) from either inside the heater control enclosure or in the Remote Control Station. (*Optional*)

Maxitrol Series 44 Modulating Controls (Optional) Electronic discharge temperature control system maintains a constant space temperature (adjustable from 40° to 80°F). Discharge temperature modulates between the minimum (adjustable from 40° to 80°F) and maximum (adjustable from 80° to 140°F) setpoints on the amplifier. Includes an adjustable space temperature control and sensor.

Maxitrol Series Signal Conditioner (SC) Electronic discharge temperature control system maintains a constant temperature rise based on analog input signal from BACnet controller or remote source. Requires external loop control to maintain constant discharge or space temperature. Includes maximum and minimum discharge air temperature limits and low fire start.

Insurance Controls Controls and gas train to comply with the requirements of Factory Mutual (FM) and/or Industrial Risk Insurers (IRI). Specify heater input and insurer for proper selection of insurance controls. All gas train options are factory mounted within the gas train enclosure.

High Pressure Regulator A positive shut-off high pressure regulator is required when the gas supply pressure exceeds the maximum gas pressure requirements or is specified by local codes or local utilities. Furnished with a manual high pressure shut-off cock and pressure tap. Venting of this regulator to outdoors is required. Specify gas supply pressure and burner input capacity for regulator selection. (field installed)

Exhaust Fan Contact Auxiliary dry contact is mechanically interlocked to operation of the heater's motor starter and provided with terminals located in heater's electrical enclosure. The dry contact is typically wired into the exhaust fan control circuit to activate the exhaust fan when the make-up air heater comes on.

Fuse Block Line fusing for branch circuit protection. Wired in conjunction with non-fused disconnect switch.

Interior Light(s) Available for: Heater Cabinet, Electrical Control Enclosure, Gas Train Enclosure
Switches located inside the heater's electrical enclosure. Furnished with safety guards. 100 watts maximum, each. Separate electrical supply source is required.

Convenience Outlet A 115 volt GFI duplex receptacle is provided inside the heater's electrical enclosure. The electrical supply source for this device can be either: The heater's control power transformer (5 amps max.) or Separate outside source (15 amps max.).

Paint Booth Control Consult factory.

BACnet Controller Factory provided BACnet MS/TP controller to monitor and control the heater. Provides status of blower, burner and alarms. Controls blower operation and gas modulation for selectable operating modes.

Kitchen Ventilation System Controls Consult factory.

Remote Control Station (RCS) Lockable NEMA 1 enclosure (9"wide x 14"high x 5"deep), equipped with a three position keylock selector switch (Summer Ventilation-Off-Heating) and indicating lights for blower operation (green), burner operation (red), reset (amber).

Remote Control Station Options

Maxitrol Series 14 Remote Heat Adjustment Dial (see page 16)

- Mounted on exterior of RCS door for easy access.
- Mounted inside RCS for tamperproof applications.

Maxitrol Series 14 Space Temperature Override An electronic space thermostat for raising the discharge temperature set on the Remote Heat Adjustment Dial by 10° to 40°F.

Maxitrol Series 44/Tamperproof Same as optional Maxitrol Series 44 (see page 16), except adjustable space thermostat control is mounted inside RCS and a space temperature sensor is field mounted in the space to be heated.

Maxitrol Series 44/Hazardous Area Same as Maxitrol Series 44/Tamperproof (see above), except epoxy coated space temperature sensor is replaced by a design with epoxy coated circuitry.

Operating Electronic Thermostat To control heater's ON/OFF operation in a space heating mode.

Non-Adjustable Thermostat A fixed temperature, solid state, epoxy sealed thermostat.

Specify temperature setpoint of: 41°F, 50°F, 55°F, 60°F, or 65°F.

Temperature Setback A combination thermostat/seven day programmable timer. It includes independent programs for summer ventilation/heating modes, separate selectable occupied/unoccupied temperatures and an override timer.

(continued on next page)

Electrical Control Options cont.

Clogged Filter Light Alarm light mounted in RCS indicates clogged filters. Includes differential pressure switch mounted in unit control enclosure to monitor pressure drop across the filters.

Manual Make-Up Air Switch A toggle switch to manually turn the heater ON/OFF.

- Mounted on exterior of RCS door for easy access
- Mounted inside RCS for tamperproof applications.

Exhaust Fan Interlock To interlock make-up air heater to an exhaust fan, such that the make-up air heater comes on when the exhaust fan comes on. Terminals are provided in RCS for wiring of dry contacts (provided by others).

VFD Control Options

The Cambridge VFD assembly varies motor speed in response to changing operating conditions. Each control package is mounted in a ventilated enclosure, factory wired and tested as part of the total M-Series Make-Up Air Heater.

VFD Control Options Include:

- Room Pressure Controller – Adjusts cfm output to maintain building pressure
- Exhaust Fan Interlock(s) – Fixed speeds selection to correspond to exhaust fan operation
- Analog Input from External Sources – Continuously adjustable based on 0-10VDC or 4-20 mA signal
- Manual Speed Control – Continuous or fixed speeds adjustment based on VFD keypad, potentiometer or multi-position switch

PLC (Programmable Logic Controller) may be incorporated with the above options

Net Room Air

The net air volume delivered to a space is the result of the heated discharge air volume cooling and contracting to the ambient room temperature. To determine net room air, multiply the discharge cfm times the ratio of the room temperature to the discharge temperature expressed in degrees Rankine (°R).

$$cfm_{Net} = cfm_{Discharge} \times \left(\frac{460 + T_{Room}}{460 + T_{Discharge}} \right)$$

Calculate the burner input using the following formula:

$$\text{Btu/hr} = \text{cfm} \times \rho \times c_p \times 60 \times \Delta T \div 0.92$$

- Where:** **cfm** is the discharge air volume of the blower
ρ is the density of the air handled by the blower (lb/ft³) (Note 1)
c_p is the specific heat of the air (0.240 Btu/lb°F)
60 is the conversion from minutes to hours
ΔT is the temperature rise (°F) (Note 2)
0.92 is the conversion from sensible heat to total heat (output to input)

Note 1: Density is calculated from the following formula:

$$\rho = 1.32605 \times (\text{Barometric pressure} \div T_{\text{Discharge}})$$

- Where:** Barometric pressure is in terms of inches of mercury ("Hg)
 (See chart on page 6 for barometric pressures for selected cities)
 Discharge temperature is in terms of degrees Rankine (°R)

$$T_{\text{Discharge}} = (460 + \text{°F})$$

Note 2: The temperature rise for make-up air heaters is typically determined by calculating the difference between the outdoor design temperature and the indoor design temperature (room temperature) plus 10 to 20°F. Use chart below to determine maximum temperature rise.

Max. Airflow (cfm)	Up to 50,000	55,000	60,000	65,000	70,000	75,000
Max. Temp. Rise at Sea Level	110°F	100°F	92°F	85°F	79°F	73°F

Summary of Limited Warranty

Cambridge Air Solutions warrants all M-Series products, including all components and sub-components thereof, to be free from defects in material and workmanship for a period of **twenty-four (24) months** from date of shipment, with the exception of the burner assembly which is warranted for **five (5) years**, provided the product is properly installed and operated under normal conditions in accordance with the Cambridge Technical Manual and any other applicable instructions and in conformance with national and local codes.

For complete warranty, see the Technical Manual.

Typical Wiring Diagram

For Maxitrol Series 14 only
(Refer to Tech Manual for other Gas Control Wiring)

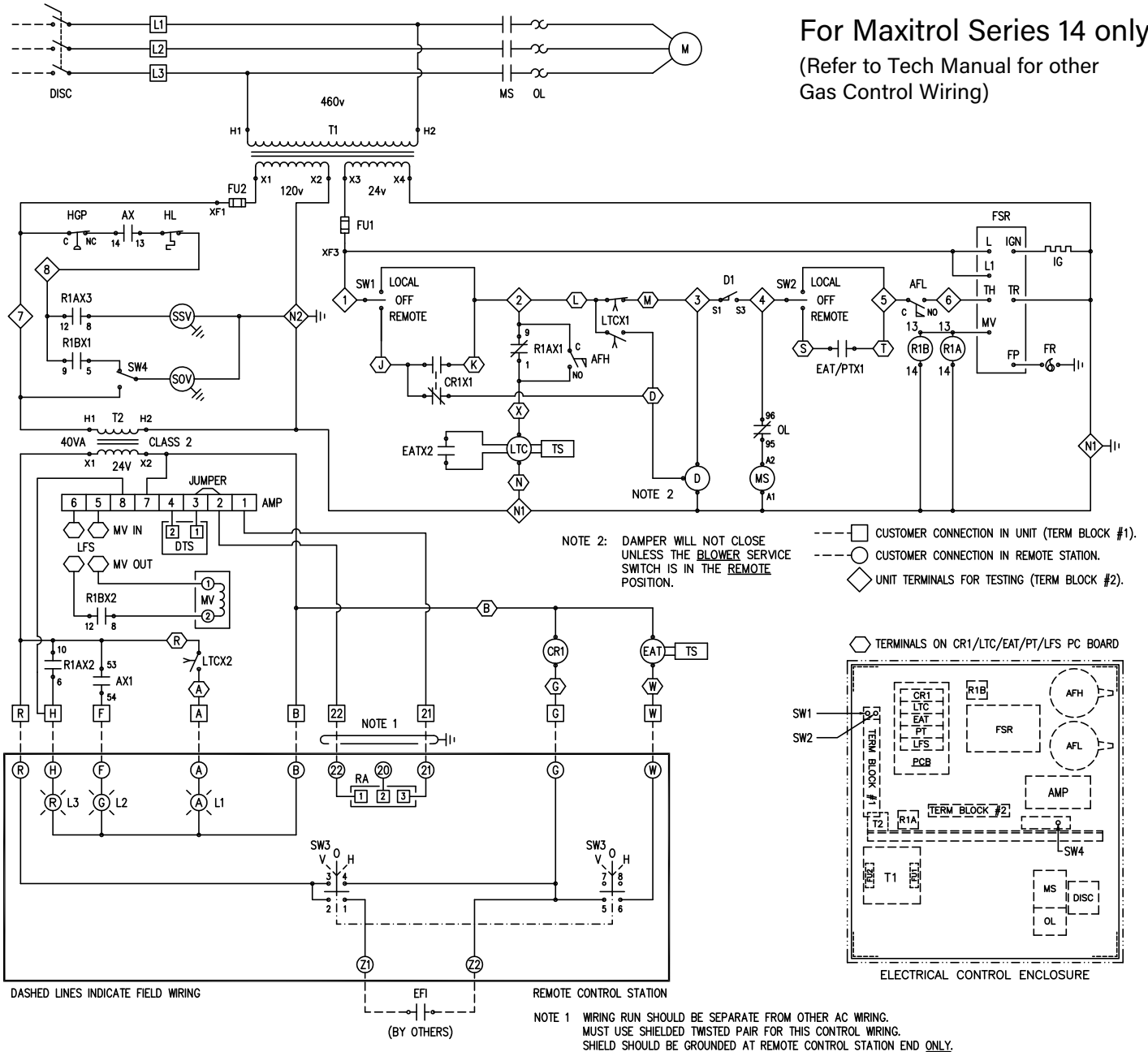

Symbol	Description
AFH	Air Flow Switch - High
AFL	Air Flow Switch- Low
AMP	Amplifier Solid State
AXI	Auxiliary Contact
AX	Auxiliary Contact
CRI	Control Relay
D & DI	Damper Motor & End Switch
DISC	Service Disconnect Non-Fused
DTS	Discharge Temperature Sensor
EAT	Entering Air Thermostat
EFI	Exhaust Fan Interlock
FR	Flame Rod
FSR	Flame Safeguard Relay (HSI)
FU1	Fuse 24 Volt Control

Symbol	Description
FU2	Fuse 120 Volt Control
HGP	High Gas Pressure Switch
HL	High Limit
IG	Igniter
L1	Light-Alarm
L2	Light-Fan
L3	Light-Heat
LFS	Low Fire Start
LTC	Low Temperature Cutout
M	Motor
MS	Motor Starter
MV	Modulating Valve
OL	Overload Relay
PCB	Printed Circuit Board

Symbol	Description
PT	Purge Timer
RA	Remote Adjust
R1A	Relay Valve-Gas
R1B	Relay Valve-Gas
SOV	Shut-Off Valve-Gas
SSV	Safety Shut-Off Valve
SW1	Service Switch-Fan
SW2	Service Switch-Heat
SW3	Switch-On/Off/Heat
SW4	Switch-SOV Leak Test
T1	Dual Output Transformer (24&120 Volt)
T2	Class 2 Transformer (24 Volt)
TS	Temperature Sensor - LTC/EAT